

AARON 950™



USER'S GUIDE

Bovie

Bovie

AARON 950™



USER'S GUIDE

This manual and the equipment it describes are for use only by qualified medical professionals trained in the particular technique and surgical procedure to be performed. It is intended as a guide for using the Aaron 950™ Electrosurgical Generator only.

Additional technical information is available in the Aaron 950™ Service Guide.

Equipment Covered in this Manual

Aaron 950™ Electrosurgical Generator:

110 VAC Model No.: A950

220 VAC Model No.: A950-220

For Information Call

Bovie Medical Corporation • 5115 Ulmerton Road, Clearwater, FL 33760-4004

U.S. Phone 1-800-537-2790 • Fax 1-800-323-1640 • International Phone +1-727-384-2323 • Fax +1-727-347-9144

www.boviemed.com • sales@boviemed.com

©2013 Bovie Medical Corporation. All rights reserved. Contents of this publication may not be reproduced without the written permission of Bovie Medical Corporation.

Aaron Part Number: MC-55-055-001 Rev. 8

CONVENTIONS USED IN THIS GUIDE

WARNING:

Indicates a potentially hazardous situation which, if not avoided, could result in death or serious injury.

CAUTION:

Indicates a hazardous situation which, if not avoided, may result in minor or moderate injury.

NOTICE:

Indicates an operating tip, a maintenance suggestion, or a hazard that may result in product damage.

TABLE OF CONTENTS

Equipment Covered in this Manual	iii
For Information Call	iii
Conventions Used in this Guide	iii
Introducing the Aaron 950™ Electrosurgical Generator	1-1
Key Features	1-2
Components and Accessories	1-2
Safety	1-2
Controls, Indicators, and Receptacles	2-1
Front Panel	2-2
Symbols on the Front Panel.....	2-3
Cut, Blend, and Coag Controls.....	2-4
Fulguration, Bipolar, and Preset Controls.....	2-5
Indicators and Receptacles	2-6
Rear and Side Panels	2-7
Symbols on the Rear Panel.....	2-7
Symbols on the Side Panel	2-7
Getting Started	3-1
Initial Inspection.....	3-2
Installing the Unit.....	3-2
Using the Aaron 950™	4-1
Inspecting the Generator and Accessories	4-2
Setup Safety	4-2
Setting Up	4-3
Using and Understanding The Aaron 950™ Memory Features	4-4
Storing and Recalling Preset Settings.....	4-4
Preparing for Monopolar Surgery	4-4
Applying the Patient Return Electrode	4-4
Preparing for Bipolar Surgery	4-5
Activation Safety	4-6
Activating the Unit	4-7
Monopolar Activation.....	4-7
Bipolar Activation.....	4-7
Maintaining the Aaron 950™	5-1
Cleaning	5-2
Periodic Inspection	5-2
Troubleshooting	6-1
Repair Policy and Procedures	7-1
Responsibility of the Manufacturer	7-2
Returning the Generator for Service	7-2
Step 1 – Obtain a Returned Goods Authorization Number.....	7-2
Step 2 – Clean the Generator	7-2
Step 3 – Ship the Generator	7-2

Technical Specifications	A-1
Performance Characteristics	A-2
Input Power	A-2
Duty Cycle	A-2
Dimensions and Weight	A-2
Operating Parameters	A-2
Transport and Storage	A-2
Audio Volume	A-3
Low Frequency (50–60 Hz) Leakage Current	A-3
High Frequency (RF) Leakage Current	A-3
Standards and IEC Classifications	A-4
Class I Equipment (IEC 60601-1)	A-4
Type BF Equipment (IEC 60601-1) / Defibrillator Proof	A-4
Drip Proof (IEC 60601-2-2)	A-4
Electromagnetic Interference	A-4
Electromagnetic Compatibility (IEC 60601-1-2 and IEC 60601-2-2)	A-4
Voltage Transients (Emergency Generator Mains Transfer)	A-4
EMC Compliance	A-4
Output Characteristics	A-8
Maximum Output for Bipolar and Monopolar Modes	A-8
Output Power Curves	A-9
Monopolar Cut Curves	A-9
Monopolar Coag Curves	A-11
Bipolar Curves	A-13
Warranty	B-1

LIST OF FIGURES

Figure 2 – 1	Layout of controls, indicators, and receptacles on the front panel	2-2
Figure 2 – 2	Controls for the cut, blend, and coag modes	2-4
Figure 2 – 3	Controls for the fulguration and bipolar modes and presets	2-5
Figure 2 – 4	Indicators and receptacles.....	2-6
Figure 2 – 5	Layout of controls and indicators on the rear and side panels.....	2-7
Figure 3 – 1	Mounting kit	3-2
Figure 4 – 1	Setup procedures	4-8
Figure A – 1	Output power versus impedance for cut mode.....	A-9
Figure A – 2	Peak voltage versus power setting for cut mode	A-9
Figure A – 3	Output power versus impedance for blend mode.....	A-10
Figure A – 4	Peak voltage versus power setting for blend mode	A-10
Figure A – 5	Output power versus impedance for coagulation mode	A-11
Figure A – 6	Peak voltage versus power setting for coagulation mode	A-11
Figure A – 7	Output power versus impedance for fulguration mode	A-12
Figure A – 8	Peak voltage versus power setting for fulguration mode	A-12
Figure A – 9	Output power versus impedance for bipolar mode.....	A-13
Figure A – 10	Peak voltage versus power setting for bipolar mode	A-13

INTRODUCING THE AARON 950™ ELECTROSURGICAL GENERATOR

This section includes the following information:

- *Key Features*
- *Components and Accessories*
- *Safety*

.....
CAUTIONS

Read all warnings, cautions, and instructions provided with this generator before using.

.....
Read the instructions, warnings, and cautions provided with electrosurgical accessories before using. Specific instructions are not included in this manual.
.....

KEY FEATURES

The Aaron 950™ Electrosurgical Generator includes the latest technology. This unit offers unsurpassed performance, flexibility, reliability, and convenience.

It includes the following features:

- **Two levels of coagulation: Pinpoint Coagulation and Fulguration**
Pinpoint Coagulation provides precise control of bleeding in localized areas.
Fulguration provides greater control of bleeding in highly vascular tissue over broad surface areas.
- **Presets**
The unit incorporates six user-defined presets for easy recall of frequently used settings.
- **Isolated RF output for Cut, Blend, and Coag modes**
This minimizes the potential of alternate site burns.
- **Ground Referenced RF output for Fulguration mode**
- **Self diagnostics**
These diagnostics continually monitor the unit to ensure proper performance.

COMPONENTS AND ACCESSORIES

To avoid incompatibility and unsafe operation, we recommend using the following Bovie® or Aaron® brand accessories supplied with your generator:

- Aaron 950™ Electrosurgical Generator
- 50 sharp and 50 blunt non-sterile dermal tips
- Five disposable electrodes (3 blades, 1 ball, 1 needle)
- One reusable grounding cord
- Five disposable grounding pads
- A901 Handpiece
- Ten A910 handpiece drapes
- Hospital-grade power cord
- Wall mount bracket
- User's Guide

SAFETY

The safe and effective use of electrosurgery depends to a large degree on factors solely under the control of the operator. There is no substitute for a properly trained and vigilant medical staff. It is important that they read, understand, and follow the operating instructions supplied with this electrosurgical equipment.

Physicians have used electrosurgical equipment safely in numerous procedures. Before starting any surgical procedure, the surgeon should be familiar with the medical literature, complications, and hazards of using electrosurgery in that procedure.

To promote the safe use of the Aaron 950™ Electrosurgical Generator, this section presents the warnings and cautions that appear throughout this user's guide. So that you can operate this equipment with maximum safety, it is important that you read, understand, and follow the instructions in these warnings and cautions. It is also important that you read, understand, and follow the instructions for use in this user's guide.

WARNINGS:

Hazardous Electrical Output - This equipment is for use only by trained, licensed physicians.

Danger: Fire / Explosion Hazard - Do not use the Aaron 950™ electrosurgical generator in the presence of flammable anesthetics.

WARNINGS:

Fire / Explosion Hazard - The following substances will contribute to increased fire and explosion hazards in the operating room:

- Flammable substances (such as alcohol based skin prepping agents and tinctures)
- Naturally occurring flammable gases which may accumulate in body cavities such as the bowel
- Oxygen enriched atmospheres
- Oxidizing agents (such as nitrous oxide [N₂O] atmospheres)

The sparking and heating associated with electrosurgery can provide an ignition source. Observe fire precautions at all times. When using electrosurgery in the same room with any of these substances or gases, prevent their accumulation or pooling under surgical drapes, or within the area where electrosurgery is performed.

Connect the power cord to a properly polarized and grounded power source with the frequency and voltage characteristics that match those listed on the back of the unit.

Electric Shock Hazard - Connect the generator power cord to a properly grounded receptacle. Do not use power plug adapters.

Electric Shock Hazard - Always turn off and unplug the generator before cleaning.

Fire Hazard - Do not use extension cords.

Patient Safety - Use the generator only if the self-test has been completed as described. Otherwise, inaccurate power outputs may result.

Failure of the high frequency electrosurgical equipment could result in an unintended increase of output power.

The instrument receptacles on this generator are designed to accept only one instrument at a time. Do not attempt to connect more than one instrument at a time into a given receptacle. Doing so will cause simultaneous activation of the instruments.

Use the lowest output setting necessary to achieve the desired surgical effect. Use the active electrode only for the minimum time necessary in order to lessen the possibility of unintended burn injury. Pediatric applications and/or procedures performed on small anatomic structures may require reduced power settings. The higher the current flow, and the longer the current is applied, the greater the possibility of unintended thermal damage to tissue, especially during use on small structures.

Use electrosurgery with caution in the presence of internal or external devices such as pacemakers or pulse generators. Interference produced by the use of electrosurgical devices can cause devices such as pacemakers to enter an asynchronous mode or can block the pacemaker effect entirely. Consult the device manufacturer or hospital Cardiology Department for further information when use of electrosurgical appliances is planned for patients with cardiac pacemakers or other implantable devices.

If the patient has an Implantable Cardioverter Defibrillator (ICD), contact the ICD manufacturer for instructions before performing an electrosurgical procedure. Electrosurgery may cause multiple activation of ICDs.

Do not use electrosurgical equipment unless properly trained to use it in the specific procedure being undertaken. Use by physicians without such training has resulted in serious, unintended patient injury, including bowel perforation and unintended, irreversible tissue necrosis.

For surgical procedures where the high frequency current could flow through parts of the body having a relatively small cross-sectional area, the use of bipolar techniques may be desirable to avoid unwanted coagulation.

In some circumstances, potential exists for alternate site burns at points of skin contact (e.g., between the arm and the side of the body). This occurs when electrosurgical current seeks a path to the patient return electrode that includes the skin-to-skin contact point. Current passing through small skin-to-skin contact points is concentrated and may cause a burn. This is true for grounded, ground referenced, and isolated output generators. To reduce the potential for alternate site burns, do one or more of the following:

- Avoid skin-to-skin contact points, such as fingers touching leg, when positioning the patient.
- Place 5 to 8 cm (2 to 3 in.) of dry gauze between contact points to ensure that contact does not occur.

WARNINGS:

- Position the patient return electrode to provide a direct current route between the surgical site and the return electrode which avoids skin-to-skin contact areas.
- In addition, place patient return electrodes according to the manufacturer's instructions.

Potential for alternate site burns increases if the return electrode is compromised.

Do not wrap the accessory cords or patient return electrode cords around metal objects. This may induce currents that could lead to shocks, fires, or injury to the patient or surgical team.

CAUTIONS:

At no time should you touch the active electrode or bipolar forceps. A burn could result.

Do not stack equipment on top of the generator or place the generator on top of electrical equipment. These configurations are unstable and/or do not allow adequate cooling.

Provide as much distance as possible between the electrosurgical generator and other electronic equipment (such as monitors). An activated electrosurgical generator may cause interference with them.

Nonfunction of the generator may cause interruption of surgery. A backup generator should be available for use.

Do not turn the activation tone down to an inaudible level. The activation tone alerts the surgical team when an accessory is active.

When using a smoke evacuator in conjunction with the electrosurgical generator, place the smoke evacuator a distance from the generator and set the generator volume control at a level that ensures that the activation tones can be heard.

The use of high frequency current can interfere with the function of other electromagnetic equipment.

When high frequency surgical equipment and physiological monitoring equipment are used simultaneously on the same patient, place any monitoring electrodes as far as possible from the surgical electrodes. Monitoring systems incorporating high frequency current limiting devices are recommended.

Do not use needles as monitoring electrodes during electrosurgical procedures. Inadvertent electrosurgical burns may result.

To avoid the possibility of an electrosurgical burn to either the patient or the physicians, do not allow the patient to come in contact with a grounded metal object during activation. When activating the unit, do not allow direct skin contact between the patient and the physician.

Remove any loose fitting jewelry from the patient before activation.

Examine all accessories and connections to the electrosurgical generator before use. Ensure that the accessories function as intended. Improper connection may result in arcs, sparks, accessory malfunction, or unintended surgical effects.

When not using active accessories, place them in a holster or in a clean, dry, nonconductive, and highly visible area not in contact with the patient. Inadvertent contact with the patient may result in burns.

Studies have shown that smoke generated during electrosurgical procedures can be potentially harmful to patients and the surgical team. These studies recommend adequately ventilating the smoke by using a surgical smoke evacuator or other means.¹

1. U.S. Department of Health and Human Services. National Institute for Occupational Safety and Health (NIOSH). Control of Smoke from Laser / Electric Surgical Procedures. HAZARD CONTROLS, Publication No. 96-128, September, 1996.

NOTICE:

Do not clean the generator with abrasive cleaning or disinfectant compounds, solvents, or other materials that could scratch the panels or damage the generator.

Section 2

CONTROLS, INDICATORS, AND RECEPTACLES

This section describes:

- The Front, Rear, and Side Panels*
- Controls, Indicators, and Receptacles*

















FRONT PANEL

Figure 2 – 1 Layout of controls, indicators, and receptacles on the front panel



Symbols on the Front Panel

The following table lists descriptions for symbols found on the front panel of the Aaron 950™.

SYMBOLS	DESCRIPTION
<i>Generator Controls</i>	
	Cut mode
	Blend mode
	Coagulation mode
<i>High Frequency Desiccator Controls</i>	
	Bipolar mode
	Fulguration mode
<i>Presets</i>	
	Select next preset
	Set new preset
<i>Indicators</i>	
	RF ground referenced
	Defibrillator proof type BF equipment
	RF Isolated – patient connections are isolated from earth at high frequency.
	Read instructions before use.
	Caution - high voltage
<i>Handpiece Connectors</i>	
	Monopolar handpiece
	Patient return electrode
	Footswitch
	Bipolar forceps

CUT, BLEND, AND COAG CONTROLS

Figure 2 – 2 Controls for the cut, blend, and coag modes

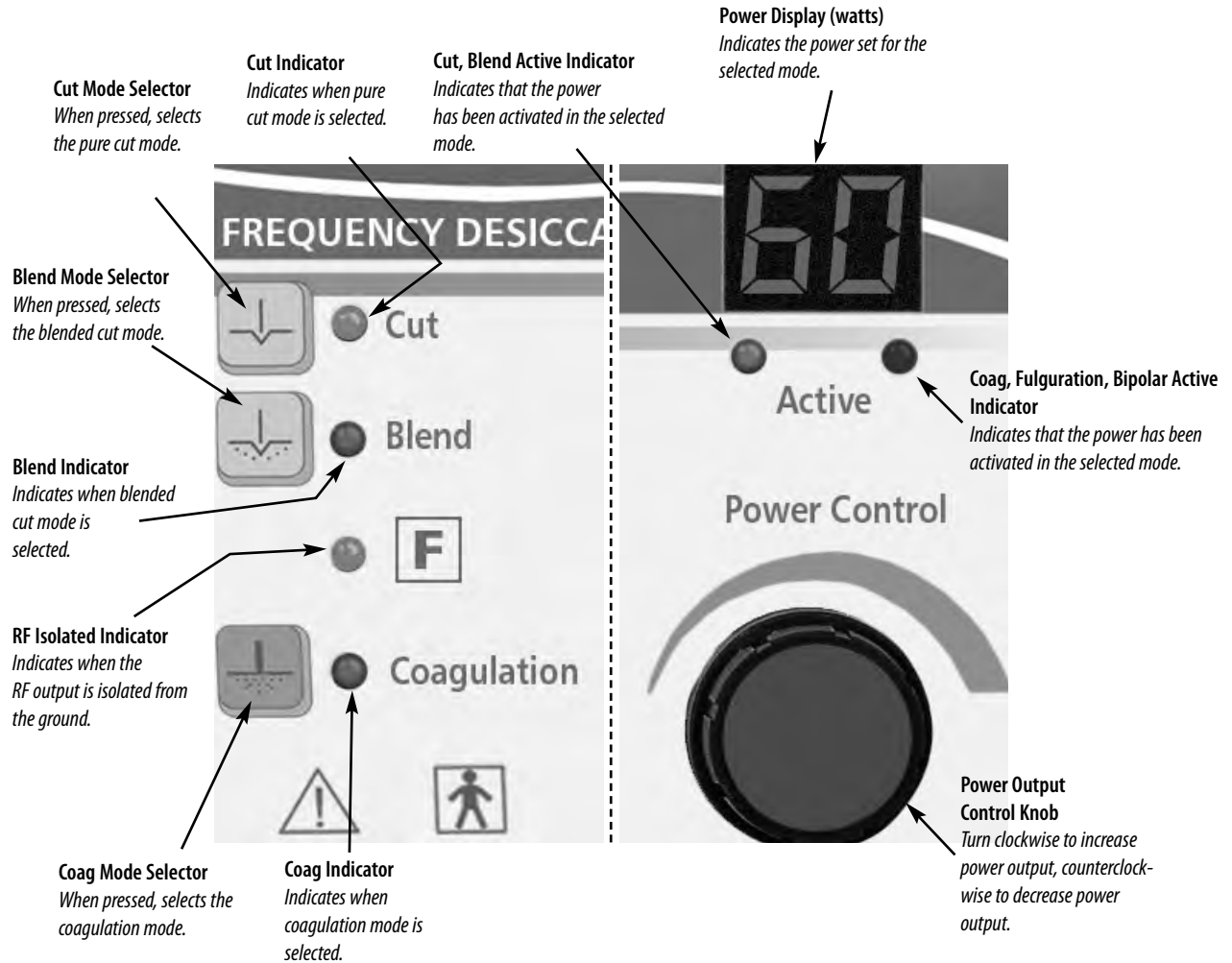

FULGURATION, BIPOLAR, AND PRESET CONTROLS

Figure 2 – 3 Controls for the fulguration and bipolar modes and presets

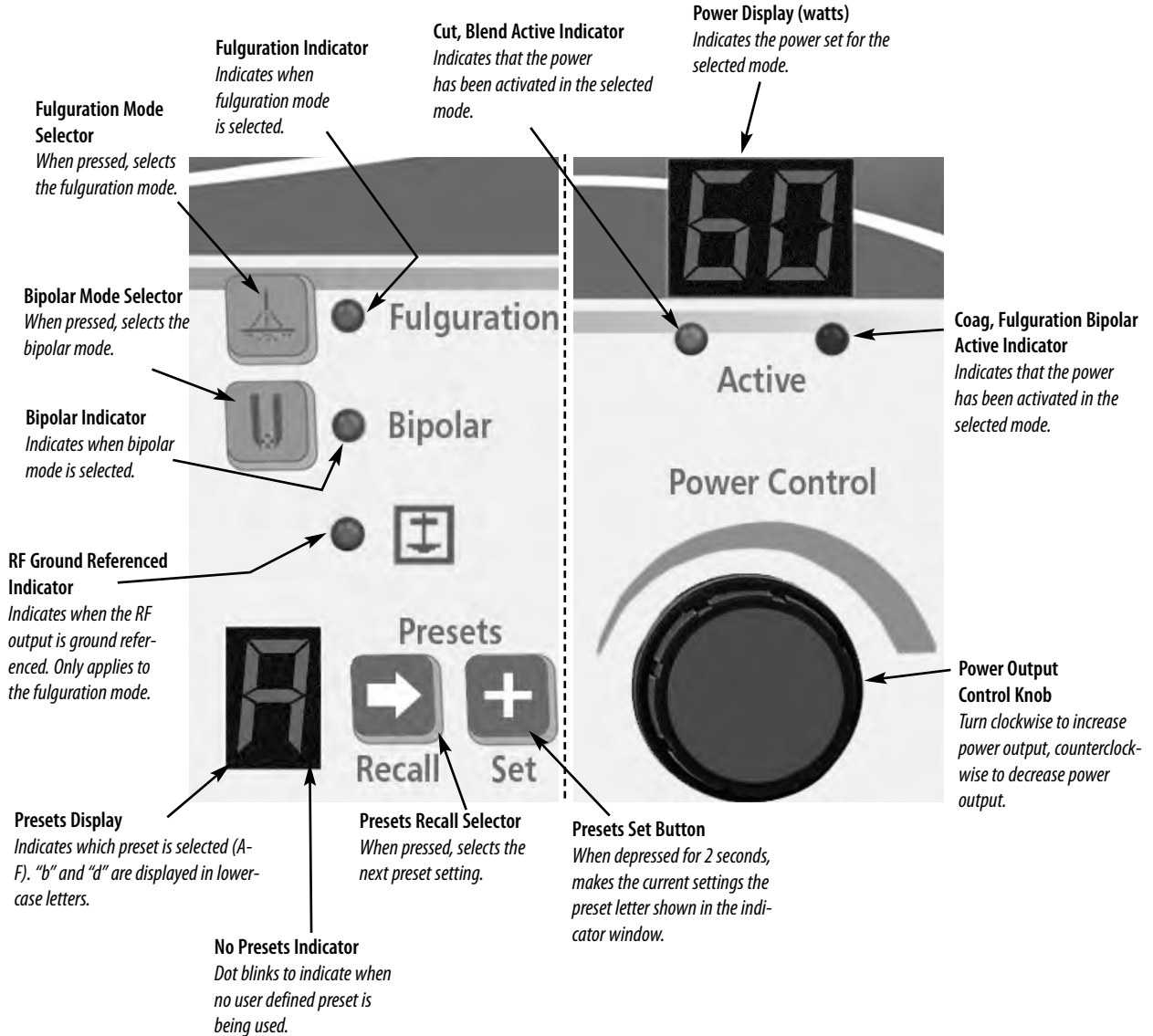

INDICATORS AND RECEPTACLES

Figure 2 – 4 Indicators and receptacles

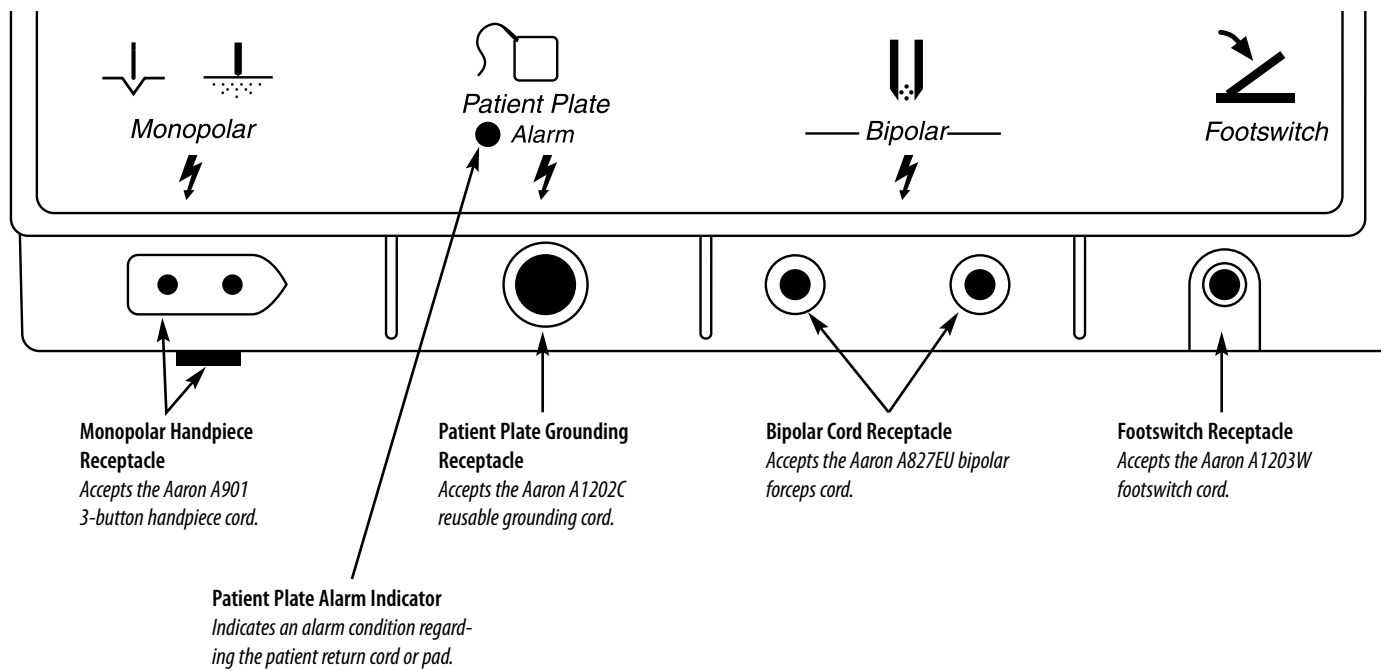

REAR AND SIDE PANELS

Figure 2 – 5 Layout of controls and indicators on the rear and side panels



Symbols on the Rear Panel

SYMBOLS	DESCRIPTION
	Volume control
	Fuse enclosed
	Read Instructions Before Use
	Do not dispose of this device in the unsorted municipal waste stream.
	Manufacturer

NOTICE:

Please note that infected medical devices must be disposed of as medical/biohazard waste and cannot be included in used electronic equipment disposal/recycling programs. In addition, certain electronic products must be returned directly to Bovie Medical Corporation. Contact your Bovie® sales representative for return instructions.

Symbols on the Side Panel

SYMBOLS	DESCRIPTION
	Non-ionizing Radiation
	Danger - Explosion Risk If Used With Flammable Anesthetics.

Section 3

GETTING STARTED

This section includes the following information:

- *Initial Inspection*
- *Installing the Unit*

INITIAL INSPECTION

When you first unpack your Aaron 950™ Electrosurgical Generator, inspect it visually:

- Look for any signs of damage.
- Verify that the shipping package contains all items listed on the packing list.

If the unit or any accessories are damaged, notify Bovie Medical Corporation's Customer Service immediately. Do not use any damaged equipment.

INSTALLING THE UNIT

1. Mount the Aaron 950™ Electrosurgical Generator on the wall or optional stand using the mounting kit.

(See Figure 3 - 1)

.....
CAUTION:

The unit is not to be utilized in the horizontal position, as liquids may easily spill into the unit. If mounting on a wall surface, a qualified individual should be consulted to avoid damage to the wall surface.
.....

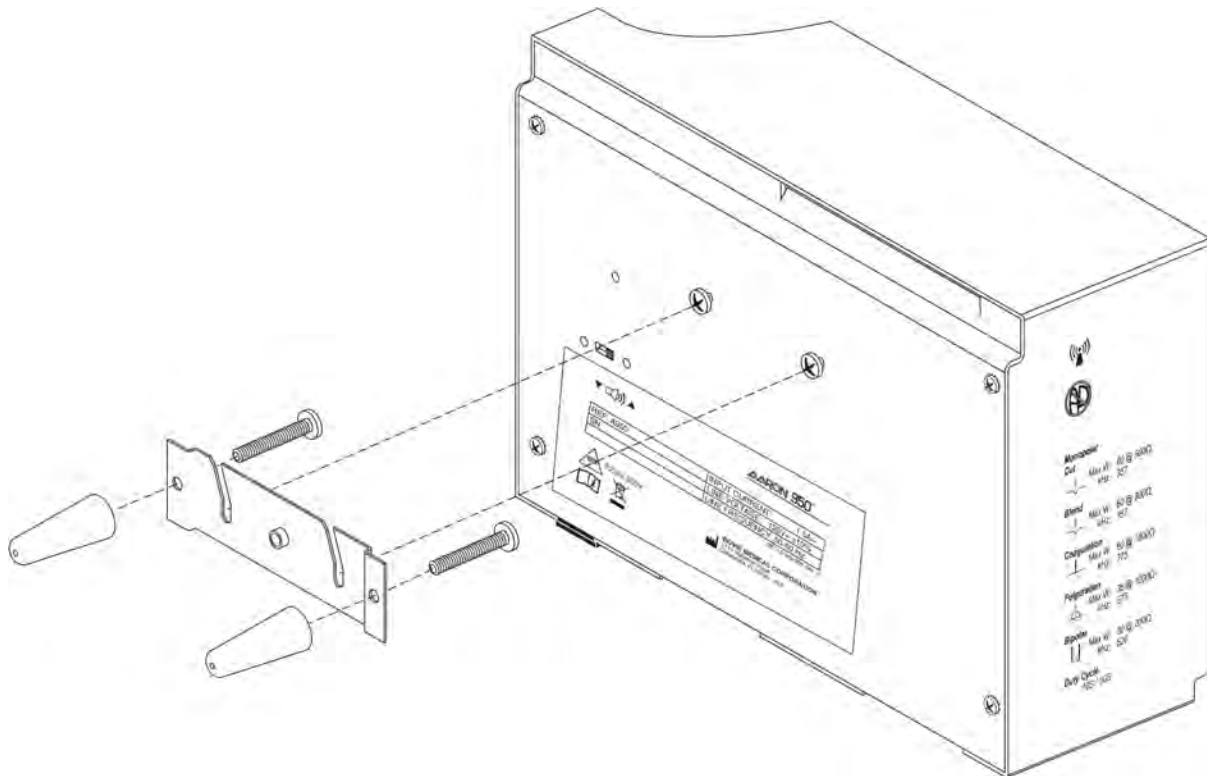

Figure 3 – 1 Mounting kit

2. Plug the female end of the supplied power cord into the base of the unit and the male end into a grounded wall receptacle.

WARNING:

Connect the power cord to a properly polarized and grounded power source with the frequency and voltage characteristics that match those listed on the back of the unit.

Section 4

USING THE AARON 950™

This section contains the following procedures:

- *Inspecting the Generator and Accessories*
- *Setup Safety*
- *Setting Up*
- *Preparing for Monopolar Surgery*
- *Preparing for Bipolar Surgery*
- *Activation Safety*
- *Activating the Unit*

CAUTIONS

Read all warnings, cautions, and instructions provided with this generator before use.

Read the instructions, warnings, and cautions provided with electro-surgical accessories before use. Specific instructions are not included in this manual.

INSPECTING THE GENERATOR AND ACCESSORIES

Before each use of the Aaron 950™ Electrosurgical Generator, verify that the unit and all accessories are in good working order:

- Inspect for damage to the Electrosurgical Generator and all its connections.
- Verify that the appropriate accessories and adapters are present.
- Inspect all cords and connectors for signs of wear, damage, and abrasion.
- Verify that no errors occur when you turn on the unit.

SETUP SAFETY

WARNINGS

Hazardous Electrical Output - This equipment is for use only by trained, licensed physicians.

Electric Shock Hazard - Connect the generator power cord to a properly grounded receptacle. Do not use power plug adapters.

Connect the power cord to a properly polarized and grounded power source with the frequency and voltage characteristics that match those listed on the back of the unit.

Fire Hazard - Do not use extension cords.

Patient Safety - Use the generator only if the self-test has been completed as described. Otherwise, inaccurate power outputs may result.

The instrument receptacles on this generator are designed to accept only one instrument at a time. Do not attempt to connect more than one instrument at a time into a given receptacle. Doing so will cause simultaneous activation of the instruments.

Failure of the high frequency electrosurgical equipment could result in an unintended increase of output power.

Do not use electrosurgical equipment unless properly trained to use it in the specific procedure being undertaken. Use by physicians without such training has resulted in serious, unintended patient injury, including bowel perforation and unintended, irreversible tissue necrosis.

For surgical procedures where the high frequency current could flow through parts of the body having a relatively small cross-sectional area, the use of bipolar techniques may be desirable to avoid unwanted coagulation.

If the patient has an Implantable Cardioverter Defibrillator (ICD), contact the ICD manufacturer for instructions before performing an electrosurgical procedure. Electrosurgery may cause multiple activation of ICDs.

In some circumstances, potential exists for alternate site burns at points of skin contact (e.g., between the arm and the side of the body). This occurs when electrosurgical current seeks a path to the patient return electrode that includes the skin-to-skin contact point. Current passing through small skin-to-skin contact points is concentrated and may cause a burn. This is true for grounded, ground referenced, and isolated output generators.

To reduce the potential for alternate site burns, do one or more of the following:

- Avoid skin-to-skin contact points, such as fingers touching leg, when positioning the patient.
- Place 5 to 8 cm (2 to 3 in.) of dry gauze between contact points to ensure that contact does not occur.
- Position the patient return electrode to provide a direct current route between the surgical site and the return electrode which avoids skin-to-skin contact areas.
- In addition, place patient return electrodes according to the manufacturer's instructions.

Potential for alternate site burns increases if the return electrode is compromised.

CAUTIONS

Do not stack equipment on top of the generator or place the generator on top of electrical equipment. These configurations are unstable and/or do not allow adequate cooling.

Provide as much distance as possible between the electrosurgical generator and other electronic equipment (such as monitors). An activated electrosurgical generator may cause interference with them.

Nonfunction of the generator may cause interruption of surgery. A backup generator should be available for use.

Do not turn the activation tone down to an inaudible level. The activation tone alerts the surgical team when an accessory is active.

When using a smoke evacuator in conjunction with the electrosurgical generator, place the smoke evacuator a distance from the generator and set the generator volume control at a level that ensures that the activation tones can be heard.

NOTICES

If required by local codes, connect the generator to the hospital equalization connector with an equipotential cable.

Connect the power cord to a wall outlet having the correct voltage. Otherwise product damage may result.

SETTING UP

1. If the unit is not already installed refer to Section 3 of this manual for the installation procedure.
2. Turn on the generator by pressing the power switch ON (I) (*see figure 4-1, letter G*). [*Figure 4-1 is located at the end of this Section*].
Verify the following:
 - All visual indicators and displays on the front panel illuminate.
 - Activation tones sound to verify that the speaker is working properly.
3. If the self-test is successful, a tone sounds. Verify the following:
 - The unit resets to the last activated Preset setting. The Preset display will display a letter from A-F. Preset letters “b” and “d” will display in lowercase.
 - The power display will show the power level for the last used Preset setting.
 - The mode for the last activated Preset setting is selected.

If the self-test is not successful, an alarm tone sounds. An error code may appear on the power display, in most cases, the generator is disabled. Note the error code and refer to *Section 6, Troubleshooting*.

Once the self-test is successful, connect the accessories and set the generator controls. Refer to *Preparing for Monopolar Surgery* or *Preparing for Bipolar Surgery* later in this section.

USING AND UNDERSTANDING THE AARON 950™ MEMORY FEATURES

The Aaron 950™ incorporates six user-defined Presets for easy recall of frequently used settings.

Storing and Recalling Preset Settings

Select the desired preset location (A-F) by pressing the Recall button (*see figure 4-1, letter H*).

Select the desired mode to be stored by pressing one of the mode membrane switches (*see figure 4-1, letter A*)

Select the desired power to be stored by utilizing the power output control knob. (*see figure 4-1, letter J*).

Once all the settings are selected, depress and hold the Presets Set Button (*see figure 4-1, letter I*) for 2 seconds.

To indicate the settings have been stored, the letter on the Presets indicator will blink.

To recall a preset simply press the Presets Recall button to toggle through all the presets.

NOTICE:

A small dot blinking in the lower left corner of the Presets indicator indicates that the unit is not presently set to a user-defined preset.

PREPARING FOR MONOPOLAR SURGERY

Cut, Blend, and Coagulation modes require a patient return electrode.

Applying the Patient Return Electrode

Refer to the manufacturer's instructions for application site and placement procedures. When using metal plate patient return electrodes, use a conductive gel specifically designed for electrosurgery. Select a patient return electrode site with good blood flow. While a properly applied electrode results in minimal tissue heating beneath the electrode, a good blood flow helps carry heat away from the site.

1. Plug the handpiece into the monopolar output on the lower left of the front of the unit (*see figure 4-1, letter B*).
The plug is designed to fit in only one direction. Plug the smaller round connector from the handpiece into the receptacle on the bottom of the unit. The three button handpiece is designed to give the doctor complete fingertip control of the power settings. The Aaron A901 handpiece is unique: handpieces manufactured by other manufacturers will not function with this unit. Do not use the Aaron A901 handpiece on other brand units.
2. Slide the desired active electrode into the handpiece until it is firmly seated (*see figure 4-1, letter M*). The handpiece will accept most standard 3/32" (.24 cm) electrodes.
3. Slide the handpiece from above into the holder on the right side of the unit.
4. Plug the male end of the reusable grounding cord into the Patient Plate receptacle located to the right of the monopolar output (*see figure 4-1, letter C*). Remove the disposable dispersive electrode from its pouch and attach to the snap connector on the end of the reusable grounding cord.

NOTICE:

A return electrode is not required for the fulguration mode. The patient plate alarm is not used for this mode. Procedures may be performed without the use of a return electrode.

5. An optional footswitch may be used with monopolar procedures. If the footswitch is utilized, plug the footswitch cable into the footswitch jack (*see figure 4-1, letter E*). While using a footswitch the output will be delivered via the handpiece. The activation button on the handpiece will continue to function while a footswitch is connected to the unit.

-
6. Choose the Monopolar mode of operation by pressing the desired membrane switch on the front panel (*see figure 4-1, letter A*). Monopolar modes include Cut, Blend, Coagulation, and Fulguration.
 7. Set the output power either by using the dial on the front of the unit (*see figure 4-1, letter J*) or by the up and down buttons on the handpiece (*see figure 4-1, letter K*). When power level adjustment is being made by the handpiece an audible tone will sound to indicate that the power level has been changed. Depressing and holding the up or down buttons will cause the power settings to change more rapidly for quick adjustment of the output power. Power output is displayed in one watt increments for Cut, Blend, and Coagulation mode. The maximum power for each of these modes is 60 watts. Power is displayed in “.1” watt increments below ten watts and in whole numbers from ten to 35 watts.

NOTICE:

The output settings cannot be adjusted when the unit is being activated.

8. The unit is now ready to perform surgery. Refer to *Activating the Unit* later in this section.

PREPARING FOR BIPOLAR SURGERY

1. Insert the two connectors from the bipolar cable into the bipolar cord receptacles (*see figure 4-1, letter D*).
2. Connect the desired forcep to the operating end of the bipolar cord.
3. Plug the footswitch cable into the footswitch jack (*see figure 4-1, letter E*). A footswitch is required to activate the Bipolar mode.

NOTICE:

Dispersive electrodes are not utilized during bipolar procedures.

4. Select the Bipolar mode by pressing the membrane switch on the front of the unit (*see figure 4-1, letter A*).
5. Set the output power either by using the dial on the front of the unit (*see figure 4-1, letter J*) or by the up and down buttons on the handpiece (*see figure 4-1, letter K*). When power level adjustment is being made by the handpiece an audible tone will sound to indicate that the power level has been changed. Depressing and holding the up or down buttons will cause the power settings to change more rapidly for quick adjustment of the output power. Power is displayed in “.1” watt increments below ten watts and in whole numbers from ten to 30 watts.

NOTICE:

The output settings cannot be adjusted when the unit is being activated.

6. The unit is now ready to perform surgery. Refer to *Activating the Unit* later in this section.

ACTIVATION SAFETY

WARNINGS

Do not wrap the accessory cords or patient return electrode cords around metal objects. This may induce currents that could lead to shocks, fires, or injury to the patient or surgical team.

Danger: Fire / Explosion Hazard - Do not use the Aaron 950™ Electrosurgical Generator in the presence of flammable anesthetics.

Fire / Explosion Hazard - The following substances will contribute to increased fire and explosion hazards in the operating room:

- Flammable substances (such as alcohol based skin prepping agents and tinctures)
- Naturally occurring flammable gases that may accumulate in body cavities such as the bowel
- Oxygen enriched atmospheres
- Oxidizing agents (such as nitrous oxide [N₂O] atmospheres)

The sparking and heating associated with electrosurgery can provide an ignition source. Observe fire precautions at all times. When using electrosurgery in the same room with any of these substances or gases, prevent their accumulation or pooling under surgical drapes, or within the area where electrosurgery is performed.

Use the lowest output setting necessary to achieve the desired surgical effect. Use the active electrode only for the minimum time necessary in order to lessen the possibility of unintended burn injury. Pediatric applications and/or procedures performed on small anatomic structures may require reduced power settings. The higher the current flow, and the longer the current is applied, the greater the possibility of unintended thermal damage to tissue, especially during use on small structures.

Use electrosurgery with caution in the presence of internal or external devices such as pacemakers or pulse generators. Interference produced by the use of electrosurgical devices can cause devices such as pacemakers to enter an asynchronous mode or can block the pacemaker effect entirely. Consult the device manufacturer or hospital Cardiology Department for further information when use of electrosurgical appliances is planned for patients with cardiac pacemakers or other implantable devices.

CAUTIONS

The use of high frequency current can interfere with the function of other electromagnetic equipment.

When high frequency surgical equipment and physiological monitoring equipment are used simultaneously on the same patient, place any monitoring electrodes as far as possible from the surgical electrodes. Monitoring systems incorporating high frequency current limiting devices are recommended.

Do not use needles as monitoring electrodes during electrosurgical procedures. Inadvertent electrosurgical burns may result.

To avoid the possibility of an electrosurgical burn to either the patient or the physicians, do not allow the patient to come in contact with a grounded metal object during activation. When activating the unit, do not allow direct skin contact between the patient and the physician.

Remove any loose fitting jewelry from the patient before activation.

Examine all accessories and connections to the electrosurgical generator before use. Ensure that the accessories function as intended. Improper connection may result in arcs, sparks, accessory malfunction, or unintended surgical effects.

When not using active accessories, place them in a holster or in a clean, dry, nonconductive, and highly visible area not in contact with the patient. Inadvertent contact with the patient may result in burns.

Studies have shown that smoke generated during electrosurgical procedures can be potentially harmful to patients and the surgical team. These studies recommend adequately ventilating the smoke by using a surgical smoke evacuator or other means.¹

1. U.S. Department of Health and Human Services. National Institute for Occupational Safety and Health (NIOSH). Control of Smoke from Laser / Electric Surgical Procedures. HAZARD CONTROLS, Publication No. 96-128, September, 1996.

ACTIVATING THE UNIT

Monopolar Activation

1. If the unit is not already set up, follow the set up procedure to prepare the unit for operation.
2. Remove the handpiece from the holder. Place the handpiece in the desired position.
3. To activate the unit, depress the activation button on the handpiece (*see figure 4-1, letter L*) or depress the pedal on the footswitch. While the unit is activated, the appropriate audible tone is sounded and one of the activation LEDs will illuminate (*see figure 4-1, letter N*).
4. When the procedure is completed, turn the unit off.
5. Return the handpiece to the holder on the right side of the unit and remove the electrode. The electrode should be disposed of after each procedure. If contamination has occurred to the handpiece, the handpiece should be sterilized.

NOTICE:

When sterilizing the handpiece follow the manufacturer's sterilization instructions that accompany the handpiece.

Bipolar Activation

1. If the unit is not already set up, follow the set up procedure to prepare the unit for operation.
2. Place the forceps in the desired position.
3. To activate the unit depress the footswitch pedal. While the unit is activated, an audible tone is sounded and the blue activation LED will illuminate (*see figure 4-1, letter N*).
4. When the procedure is completed, turn the unit off.
5. Remove the forceps from the bipolar cord and sterilize.

NOTICE:

When sterilizing the forceps follow the manufactures sterilization instructions that accompany the forceps.

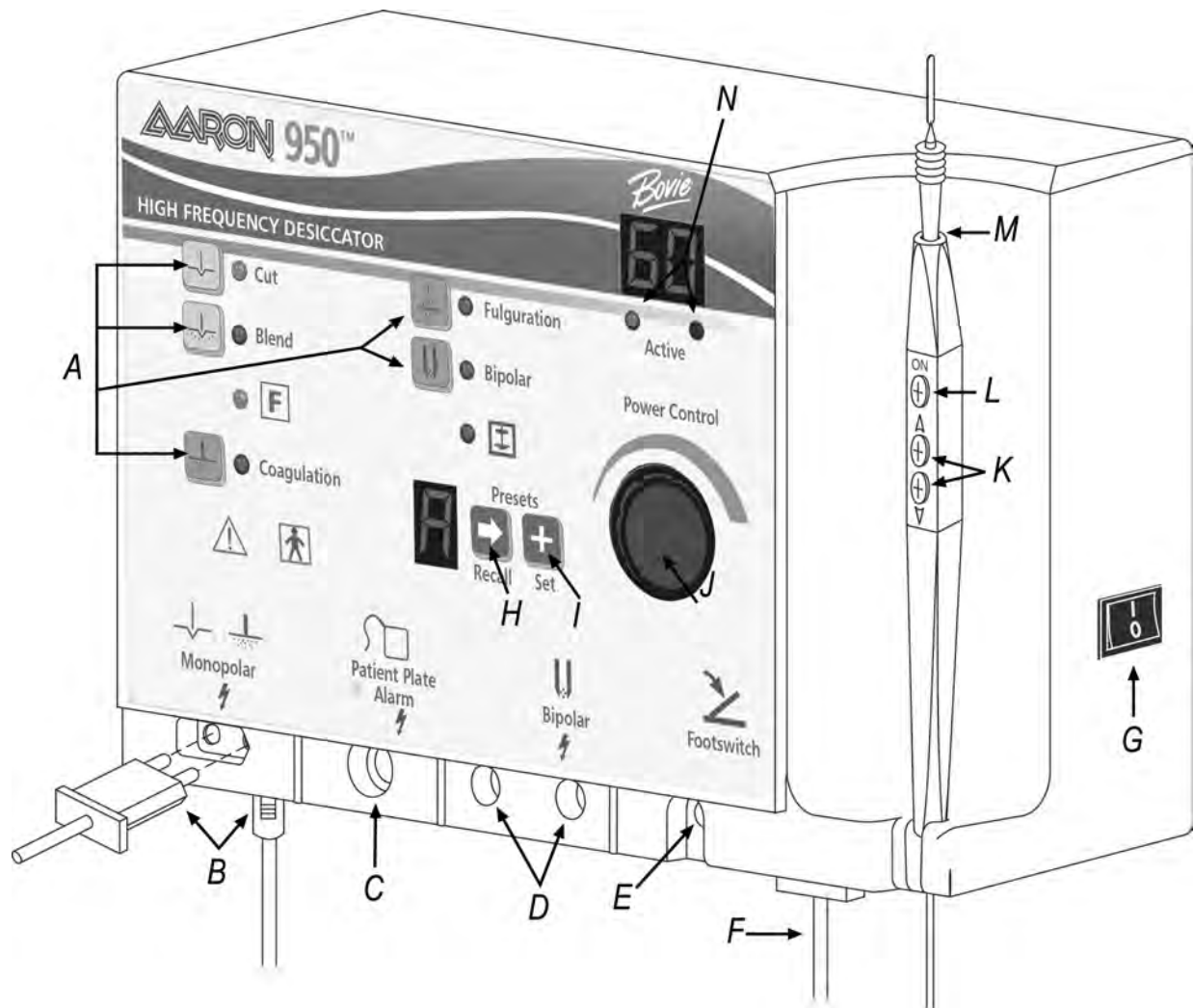

Figure 4 – 1 Setup procedures

Section 5

MAINTAINING THE AARON 950™

This section covers the following topics:

- *Cleaning*
- *Periodic Inspection*

Bovie Medical Corporation recommends that you complete periodic inspection and performance testing. Perform inspections and performance testing every six months. A qualified biomedical technician should conduct this testing to ensure that the unit is operating effectively and safely.

CLEANING

After each use, clean the unit.

WARNING:

Electric Shock Hazard - Always turn off and unplug the generator before cleaning.

NOTICE:

Do not clean the generator with abrasive cleaning or disinfectant compounds, solvents, or other materials that could scratch the panels or damage the generator.

1. Turn off the generator, and unplug the power cord from the wall outlet.
2. Thoroughly wipe all surfaces of the generator and power cord with a mild cleaning solution or disinfectant and a damp cloth. Follow the procedures approved by your institution or use a validated infection control procedure. Do not allow fluids to enter the chassis. Do not sterilize the generator.

PERIODIC INSPECTION

Every six months, visually inspect the Aaron 950™ Electrosurgical Generator for signs of wear or damage. In particular, look for any of the following problems:

- Damage to the power cord
- Damage to the power cable receptacle
- Obvious damage to the unit
- Damage to any receptacle
- Accumulation of lint or debris in or around the unit

Section 6

TROUBLESHOOTING

This section includes error code descriptions and actions to take to resolve them.

The Aaron 950™ Electrosurgical Generator includes automatic self-diagnostics. If the diagnostics detect an error, the system displays an error code, sounds an audible tone, and deactivates the unit output power.

Most error codes result from faults in accessories attached to the unit. The following table lists the error codes, describes the error, and recommends actions to take to resolve the error.

Error Code	Description	Recommended Action
F1	Handswitch or monopolar footswitch pedal may be stuck	<ol style="list-style-type: none"> 1. Turn off, then turn on the generator. Do not press buttons or activate accessory devices during the self-test. 2. If the error code reappears, disconnect all accessories. Turn off, then turn on the generator again. 3. If the problem persists, replace the handpiece or footswitch and repeat the restart. 4. If the error code reappears, record the number and call Bovie Medical Corporation customer service.
E2	Line voltage error (Line voltage is too high)	<ol style="list-style-type: none"> 1. Turn the unit off. 2. Verify that the unit is connected to the correct line voltage 3. If the error code reappears, record the number and contact Bovie Medical Corporation customer service.
E5	Internal temperature of the unit exceeded limit	<ol style="list-style-type: none"> 1. Turn the unit off. 2. Allow the unit to cool for 20 minutes. 3. Turn the unit on. 4. If the error code reappears, record the number and contact Bovie Medical Corporation customer service.

If the unit displays any other error code, it requires service.

REPAIR POLICY AND PROCEDURES

Refer to this section for information on:

- The Manufacturer's Responsibility
- Returning the Generator for Service

RESPONSIBILITY OF THE MANUFACTURER

Bovie Medical Corporation is responsible for the safety, reliability, and performance of the generator only under the following circumstances:

- The user has followed the installation and setup procedures in this user's guide.
- Persons authorized by Bovie Medical Corporation performed assembly operation, readjustments, modifications, or repairs.
- The electrical installation of the relevant room complies with local codes and regulatory requirements, such as IEC and BSI.
- Equipment use is in accordance with the Bovie Medical Corporation instructions for use.

For warranty information, refer to Appendix B – Warranty.

RETURNING THE GENERATOR FOR SERVICE

Before you return the generator, call your Bovie Medical Corporation representative for assistance. If instructed to send the generator to Bovie Medical Corporation, first obtain a Returned Goods Authorization Number. Then clean the Generator and ship it to Bovie Medical Corporation for service.

Step 1 – Obtain a Returned Goods Authorization Number

Call the Bovie Medical Corporation Customer Service Center to obtain a Returned Goods Authorization Number. Have the following information ready when you call:

- Hospital / clinic name / customer number
- Telephone number
- Department / address, city, state, and zip code
- Model number
- Serial number
- Description of the problem
- Type of repair to be done

Step 2 – Clean the Generator

WARNING:

Electric Shock Hazard - Always turn off and unplug the generator before cleaning.

NOTICE:

Do not clean the generator with abrasive cleaning or disinfectant compounds, solvents, or other materials that could scratch the panels or damage the generator.

- A. Turn off the generator, and unplug the power cord from the wall outlet.
- B. Thoroughly wipe all surfaces of the generator and power cord with a mild cleaning solution or disinfectant and a damp cloth. Follow the procedures approved by your institution or use a validated infection control procedure. Do not allow fluids to enter the chassis. You cannot sterilize the generator.

Step 3 – Ship the Generator

- A. Attach a tag to the generator that includes the Returned Goods Authorization Number and the information (hospital, phone number, etc.) listed in Step 1 – Obtain a Returned Goods Authorization Number.
- B. Be sure the generator is completely dry before you pack it for shipment. Package it in its original shipping container, if available.
- C. Ship the generator, prepaid, to the address given to you by the Bovie Medical Corporation Service Center.

Appendix

A

TECHNICAL SPECIFICATIONS

All specifications are nominal and subject to change without notice. A specification referred to as “typical” is within $\pm 20\%$ of a stated value at room temperature (25° C / 77° F) and a nominal input power voltage.

PERFORMANCE CHARACTERISTICS

Input Power

120 VAC \pm 10%	220 VAC \pm 10%
Mains line frequency: 50 / 60 Hz	Mains line frequency: 50 / 60 Hz
Power consumption: 240 VA	Power consumption: 240 VA
Fuses (two): 2.0 A (Slow Blow)	Fuses (two): 1.0 A (Slow Blow)

Duty Cycle

Under maximum power settings and rated load conditions (Pure Cut, 60 watt @ 500 Ω load), the generator is suitable for activation times of 10 seconds on, 30 seconds off for one hour.

Dimensions and Weight

Width	26 cm (10.25 in.)	Depth	11.4 cm (4.5 in.)
Height	17.8 cm (7.0 in.)	Weight	< 3.2 kg (< 7 lbs)

Operating Parameters

Ambient temperature range	+10° to +40° C
Relative humidity	30% to 75%, non-condensing
Atmospheric pressure	70kPa to 106kPa
Warm-up time	If transported or stored at temperatures outside the operating temperature range, allow one hour for the generator to reach room temperature before use.

Transport and Storage

Ambient temperature range	-40° to +70° C
Relative humidity	10% to 100%, including condensation
Atmospheric pressure	50kPa to 106kPa

Audio Volume

The audio levels stated below are for activation tones (bipolar, cut, and coag) and alarm tones (return electrode and system alarms) at a distance of one meter. Alarm tones meet the requirements for IEC 60601-2-2.

Activation Tone

Volume (adjustable)	40 to 65 dB
Frequency	Cut: 1 kHz Blend: 1 kHz Coagulation: 2 kHz Fulguration: 2 kHz Bipolar: 2 kHz
Duration	Continuous while the generator is activated

Alarm Tone

Volume (not adjustable)	70 dB \pm 5 dB
Frequency	2 kHz $\frac{1}{2}$ seconds / 1 kHz $\frac{1}{2}$ seconds
Duration	2 s

Low Frequency (50–60 Hz) Leakage Current

Enclosure source current, ground open	< 500 μ A
Source current, patient leads, all outputs	Normal polarity, intact ground: < 50 μ A Normal polarity, ground open: < 50 μ A Reverse polarity, ground open: < 50 μ A
Sink current at high line, all inputs	< 50 μ A

High Frequency (RF) Leakage Current

Bipolar RF leakage current	< 39 mA _{rms}
Monopolar RF leakage current (additional tolerance)	< 150 mA _{rms}

STANDARDS AND IEC CLASSIFICATIONS

Class I Equipment (IEC 60601-1)

Accessible conductive parts cannot become live in the event of a basic insulation failure because of the way in which they are connected to the protective earth conductor.

Type BF Equipment (IEC 60601-1) / Defibrillator Proof



The Aaron 950™ Electrosurgical Generator provides a high degree of protection against electric shock, particularly regarding allowable leakage currents. It is type BF equipment. Patient connections are isolated from earth and resist the effects of defibrillator discharge.

Drip Proof (IEC 60601-2-2)

The generator enclosure is constructed so that liquid spillage in normal use does not wet electrical insulation or other components which, when wet, are likely to affect adversely the safety of the generator.

Electromagnetic Interference

When other equipment is placed on or beneath an activated Bovie Medical Corporation electrosurgical generator, the Aaron 950™ Electrosurgical Generator operates without interference. The generator minimizes electromagnetic interference to video equipment used in the operating room.

Electromagnetic Compatibility (IEC 60601-1-2 and IEC 60601-2-2)

The Aaron 950™ Electrosurgical Generator complies with the appropriate IEC 60601-1-2 and IEC 60601-2-2 specifications regarding electromagnetic compatibility.

Voltage Transients (Emergency Generator Mains Transfer)

The Aaron 950™ Electrosurgical Generator operates in a safe manner when the transfer is made between line AC and an emergency generator voltage source.

EMC COMPLIANCE

Special precautions should be taken regarding the Aaron 950™. Medical Electrical Equipment needs special precautions regarding EMC and needs to be installed and put into service according to the EMC information provided in this manual.

Understand that only the Accessories supplied with or ordered from Bovie® should be used with your device. The use of accessories, transducers, and cables other than those specified, may result in increased Emissions or decreased Immunity of the Aaron 950™. The Aaron 950™ and its accessories are not suitable for interconnection with other equipment.

Portable and mobile RF communications equipment can affect Medical Electrical Equipment. The Aaron 950™ should not be used adjacent to or stacked with other equipment and that if adjacent or stacked use is necessary, the Aaron 950™ should be observed to verify normal operation in the configuration in which it will be used.

Recommended separation distances between portable and mobile RF communications equipment and the Aaron 950™

The Aaron 950™ is intended for use in an electromagnetic environment in which radiated RF disturbances are controlled. The customer or the user of the Aaron 950™ can help prevent electromagnetic interference by maintaining a minimum distance between portable and mobile RF communications equipment (transmitters) and the Aaron 950™ as recommended below, according to the maximum output power of the communications equipment.

Rated maximum output power of transmitter W	separation distance according to frequency of transmitter		
	150 kHz to 80 MHz $d = \left[\frac{3.5}{V_f} \right] \sqrt{P}$	80 MHz to 800 MHz $d = \left[\frac{3.5}{E_f} \right] \sqrt{P}$	800 MHz to 2.5 GHz $d = \left[\frac{7}{E_f} \right] \sqrt{P}$
0.01	0.12	0.12	0.23
0.1	0.38	0.38	0.73
1	1.2	1.2	2.3
10	3.8	3.8	7.3
100	12	12	23

For transmitters rated at a maximum output power not listed above, the recommended separation distance d in metres (m) can be estimated using the equation applicable to the frequency of the transmitter, where P is the maximum output power rating of the transmitter in watts (W) according to the transmitter manufacturer.

NOTE 1 At 80 MHz and 800 MHz, the separation distance for the higher frequency range applies.

NOTE 2 These guidelines may not apply in all situations. Electromagnetic propagation is affected by absorption and reflection from structures, objects and people.

Guidance and manufacturer' s declaration – electromagnetic emissions

The Aaron 950™ is intended for use in the electromagnetic environment listed below. The customer or the user of the Aaron 950™ should assure that it is used in such an environment.

Emissions test	Compliance	Electromagnetic environment - guidance
RF Emissions CISPR 11	Group 2	The Aaron 950™ must emit electromagnetic energy in order to perform its intended function. Nearby electronic equipment may be affected.
RF Emissions CISPR 11	Class A	The Aaron 950™ is suitable for use in all establishments other than domestic and those directly connected to the public low-voltage power supply network that supplies buildings used in domestic purposes.
Harmonic emissions IEC 61000-3-2	Class A	
Voltage fluctuations/flicker emissions IEC 61000-3-3	Complies	

Guidance and manufacturer' s declaration – electromagnetic immunity			
The Aaron 950™ is intended for use in the electromagnetic environment listed below. The customer or the user of the Aaron 950™ should assure that it is used in such an environment.			
Immunity test	IEC 60601 test level	Compliance level	Electromagnetic environment - guidance
Electrostatic discharge (ESD) IEC 61000–4–2	±6 kV contact ±8 kV air	±6 kV contact ±8 kV air	Floors should be wood, concrete or ceramic tile. If floors are covered with synthetic material, the relative humidity should be at least 30%.
Electrical fast transient/burst IEC 61000–4–4	±2 kV for power supply lines ±1 kV for input/output lines	±2 kV for power supply lines ±1 kV for input/output lines	Mains power quality should be that of a typical commercial or hospital environment.
Surge IEC 61000–4–5	±1 kV differential mode ±2 kV common mode	±1 kV differential mode ±2 kV common	Mains power quality should be that of a typical commercial or hospital environment.
Voltage dips, short interruptions and voltage variations on power supply input lines IEC 61000–4–11	<5 % U_t (<95 % dip in U_t) for 0.5 cycle <40 % U_t (<60 % dip in U_t) for 5 cycles 70 % U_t (<30 % dip in U_t) for 25 cycles <5 % U_t (>95 % dip in U_t) for 5 sec	<5 % U_t (<95 % dip in U_t) for 0.5 cycle <40 % U_t (<60 % dip in U_t) for 5 cycles 70 % U_t (<30 % dip in U_t) for 25 cycles <5 % U_t (>95 % dip in U_t) for 5 sec	Mains power quality should be that of a typical commercial or hospital environment. If the user of the Aaron 950™ requires continued operation during power mains interruptions, it is recommended that the Aaron 950™ be powered from an uninterruptible power supply or a battery.
Power frequency (50/60 Hz) magnetic field IEC 61000–4–8	3 A/m	3 A/m	Power frequency magnetic fields should be at levels characteristic of a typical location in a typical commercial or hospital environment.
NOTE U_t is the a.c. mains voltage prior to application of the test level.			

Guidance and manufacturer' s declaration – electromagnetic immunity continued...			
Immunity test	IEC 60601 test level	Compliance level	Electromagnetic environment - guidance
Conducted RF IEC 61000–4–6	3 Vrms 150 kHz to 80 MHz	3 Vrms	<p>Portable and mobile RF communications equipment should be used no closer to any part of the Aaron 950™, including cables, than the recommended separation distance calculated from the equation applicable to the frequency of the transmitter.</p> <p>Recommended separation distance</p> $d = \left[\frac{3.5}{V_1} \right] \sqrt{P}$
Radiated RF IEC 61000–4–3	3 V/m 80 MHz to 2.5 GHz	3 V/m	$d = \left[\frac{3.5}{E_1} \right] \sqrt{P}$ <p>80 MHz to 800 MHz</p> $d = \left[\frac{7}{E_1} \right] \sqrt{P}$ <p>800 MHz to 2.5 GHz</p> <p>where P is the maximum output power rating of the transmitter in watts (W) according to the transmitter manufacturer and d is the recommended separation distance in metres (m)</p> <p>Field strengths from fixed RF transmitters, as determined by an electromagnetic site survey,^a should be less than the compliance level in each frequency range.^b</p> <p>Interference may occur in the vicinity of equipment marked with the following  symbol.</p>
<p>NOTE 1 At 80 MHz and 800 MHz, the separation distance for the higher frequency range applies.</p> <p>NOTE 2 These guidelines may not apply in all situations. Electromagnetic propagation is affected by absorption and reflection from structures, objects and people.</p>			
<p>^a Field strengths from fixed transmitters, such as base stations for radio (cellular/cordless) telephones and land mobile radios, amateur radio, AM and FM radio broadcast and TV broadcast cannot be predicated theoretically with accuracy. To assess the electromagnetic environment due to fixed RF transmitters, an electromagnetic site survey should be considered. If the measured field strength in the location which the Aaron 950™ is used exceeds the applicable RF compliance level above, the Aaron 950™ should be observed to verify normal operation. If abnormal performance is observed, additional measures may be necessary, such as reorienting or relocating the Aaron 950™.</p> <p>^b Over the frequency range 150 kHz to 80 MHz, field strengths should be less than $[V_1]$ V/m.</p>			

OUTPUT CHARACTERISTICS

Maximum Output for Bipolar and Monopolar Modes

Power readouts agree with actual power into rated load to within 20% or 5 watts, whichever is greater.

Mode	Output Power	Output Frequency	Repetition Rate	Vpeak
Cut	60 W @ 500 Ω	357 kHz \pm 50 kHz	N / A	1.5 KV
Blend	60 W @ 800 Ω	357 kHz \pm 50 kHz	30 kHz \pm 5 kHz	2.0 KV
Coagulation	60 W @ 1000 Ω	375 kHz \pm 50 kHz	60 kHz \pm 5 kHz	3.8 KV
Fulguration	35 W @ 1000 Ω	575 kHz \pm 50 kHz	30 kHz \pm 5 kHz	6.5 KV
Bipolar	30 W @ 200 Ω	520 kHz - 14kHz + 50 kHz	19 kHz \pm 5 kHz	2.0 KV

OUTPUT POWER CURVES

The curves that follow depict the changes for each mode at specific power settings.

Monopolar Cut Curves

These measurements were taken using short (< 0.5 meter) leads. For each output power vs. impedance curve, the upper curve represents readings taken at full power; the lower curve, readings taken at half power.

Figure A – 1 Output power versus impedance for cut mode

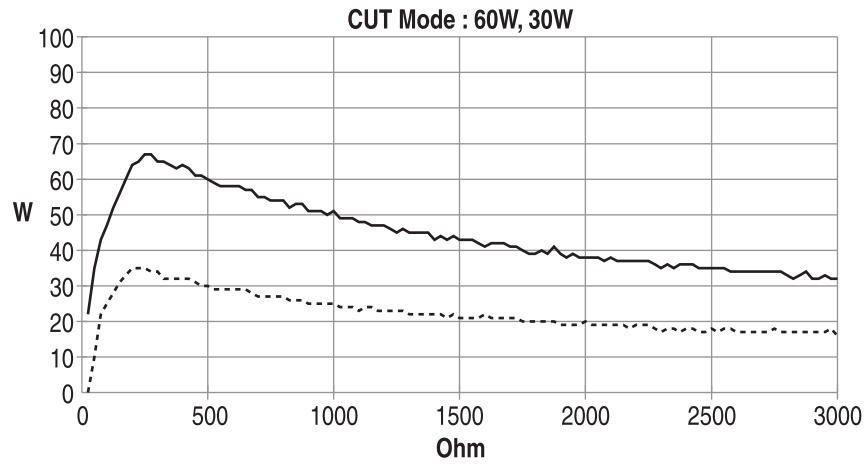

Figure A – 2 Peak voltage versus power setting for cut mode

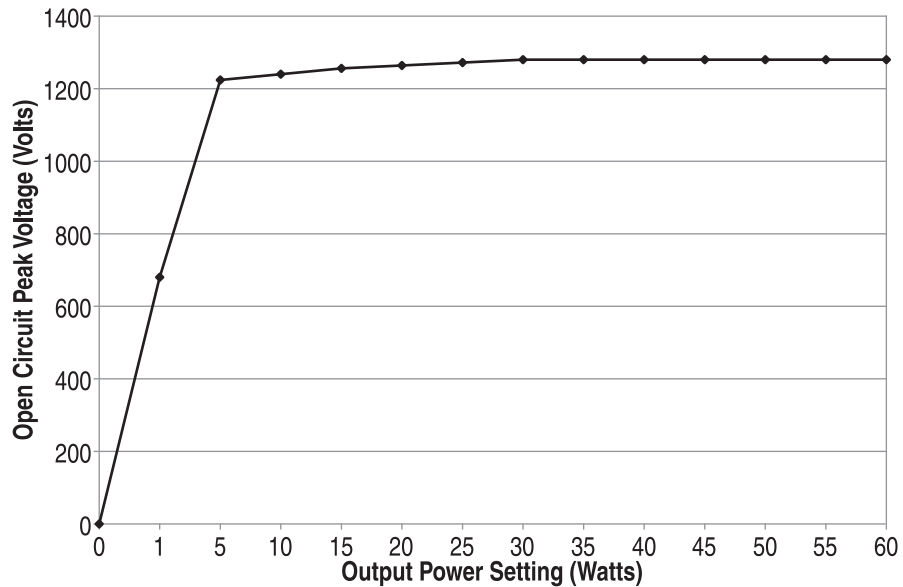

Figure A – 3 Output power versus impedance for blend mode

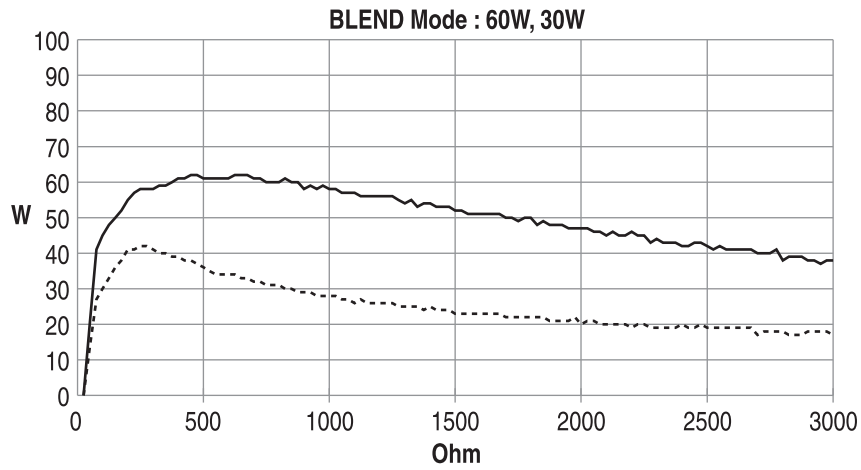
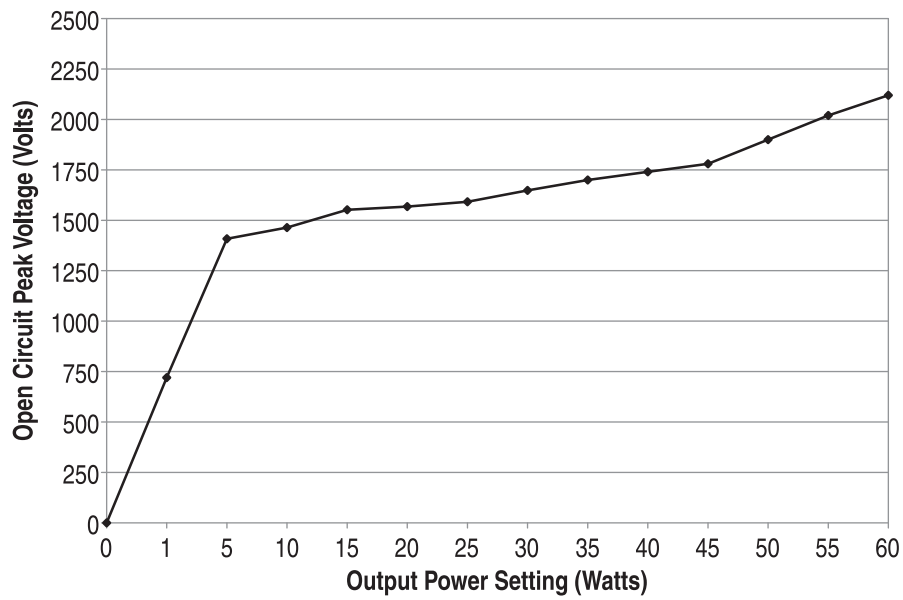

Figure A – 4 Peak voltage versus power setting for blend mode



Monopolar Coag Curves

These measurements were taken using short (< 0.5 meter) leads.

Figure A – 5 Output power versus impedance for coagulation mode

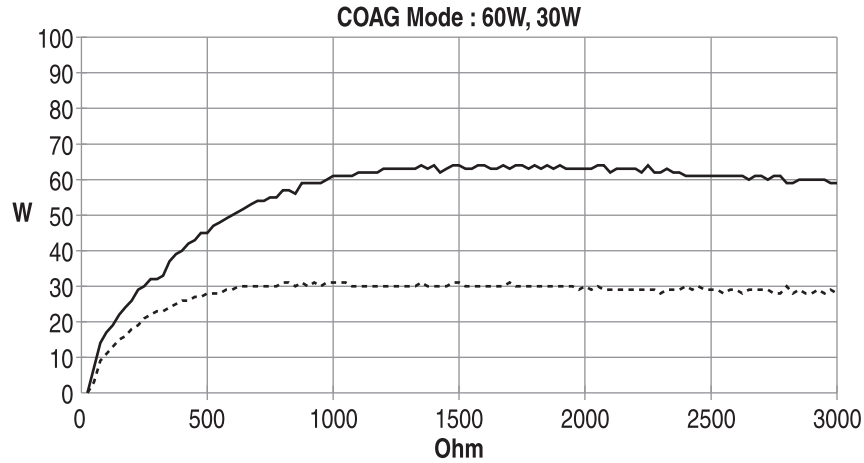

Figure A – 6 Peak voltage versus power setting for coagulation mode

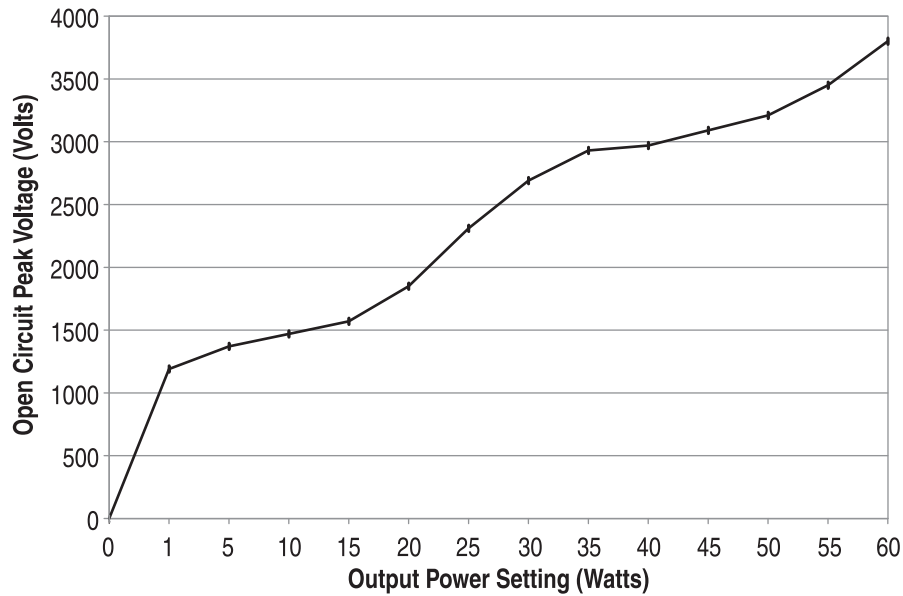

Figure A – 7 Output power versus impedance for fulguration mode

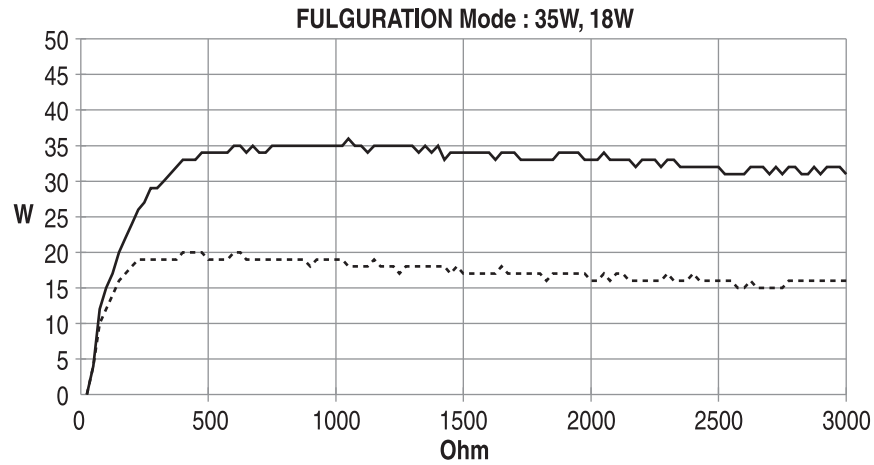
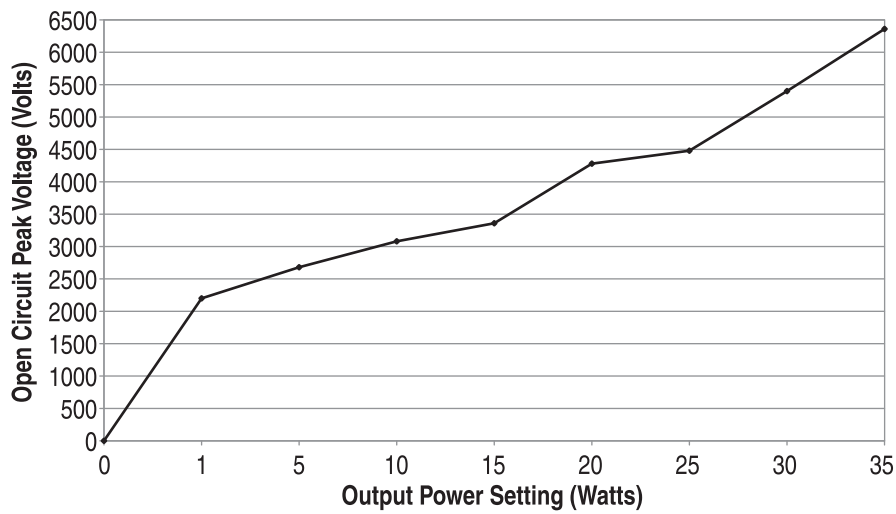

Figure A – 8 Peak voltage versus power setting for fulguration mode



Bipolar Curves

Figure A – 9 Output power versus impedance for bipolar mode

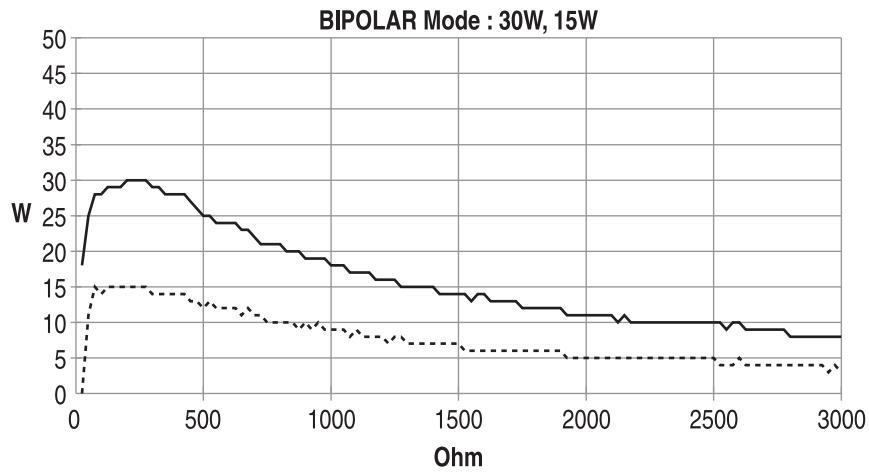
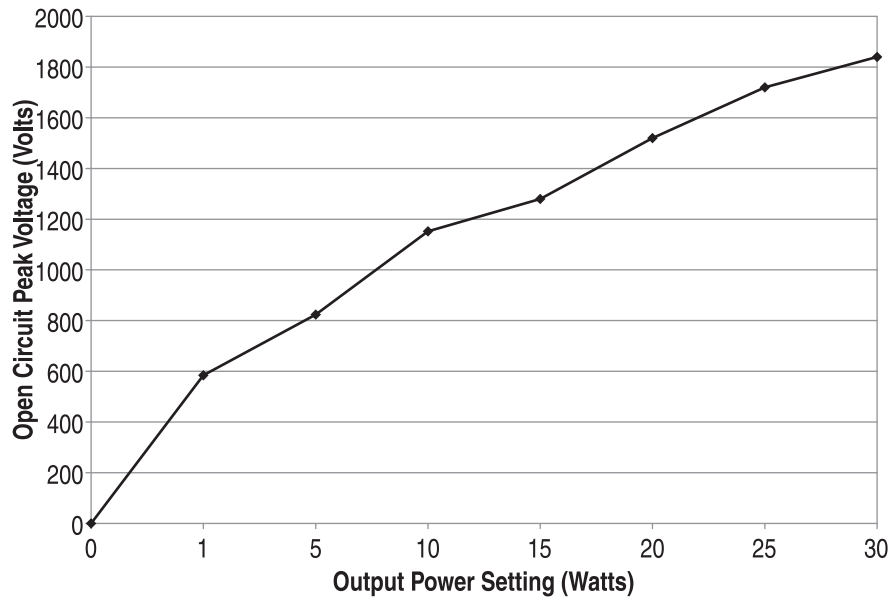

Figure A – 10 Peak voltage versus power setting for bipolar mode



Appendix B

WARRANTY

Bovie Medical Corporation warrants each product manufactured by it to be free from defects in material and workmanship under normal use and service for the period(s) set forth below.

Bovie Medical Corporation's obligation under this warranty is limited to the repair or replacement, at its sole option, of any product, or part thereof, which has been returned to it or its Distributor within the applicable time period shown below after delivery of the product to the original purchaser, and which examination discloses, to Bovie Medical Corporation's satisfaction, that the product is indeed, defective.

This warranty does not apply to any product, or part thereof, which has been repaired or altered outside Bovie Medical Corporation's factory in a way so as, in Bovie Medical Corporation's judgment, to affect its stability or reliability, or which has been subjected to misuse, neglect, or accident.

The warranty periods for Bovie Medical Corporation products are as follows:

- Electrosurgical Generators: Two years from date of shipment
- Mounting Fixtures (all models): Two years from date of shipment
- Footswitches (all models): Ninety days from date of shipment
- Patient Return Electrodes: Shelf life only as stated on packaging
- Sterile Single Use Accessories: Only as stated on packaging
- Handpiece: Only as stated on packaging

This warranty is in lieu of all other warranties, express or implied, including without limitation, the warranties of merchantability and fitness for a particular purpose, and of all other obligations or liabilities on the part of Bovie Medical Corporation.

Bovie Medical Corporation neither assumes nor authorizes any other person to assume for it any other liability in connection with the sale or use of any of Bovie Medical Corporation's products.

Notwithstanding any other provision herein or in any other document or communication, Bovie Medical Corporation's liability with respect to this agreement and products sold hereunder shall be limited to the aggregate purchase price for the goods sold by Bovie Medical Corporation to the customer.

Bovie Medical Corporation disclaims any liability hereunder or elsewhere in connection with the sale of this product, for indirect or consequential damages.

This warranty and the rights and obligations hereunder shall be construed under and governed by the laws of the State of Florida, USA.

The sole forum for resolving disputes arising under or relating in any way to this warranty is the District Court of the County of Pinellas, State of Florida, USA.

Bovie Medical Corporation, its dealers, and representatives reserve the right to make changes in equipment built and/or sold by them at any time without incurring any obligation to make the same or similar changes on equipment previously built and/or sold by them.



BOVIE MEDICAL CORPORATION

5115 Ulmerton Road

Clearwater, Florida 33760

U.S. Phone 1-800-537-2790 • Fax 1-800-323-1640

International Phone +1-727-384-2323 • www.boviemed.com

MC-55-055-001 REV.8

2013-03-19

Bovie